



**ROLLER SHADES**  
**CORDLESS HEADRAIL**

Installation Manual v2.1



#cbmblinds



**CBM**

### Assembly Parts (Standard Headrail):

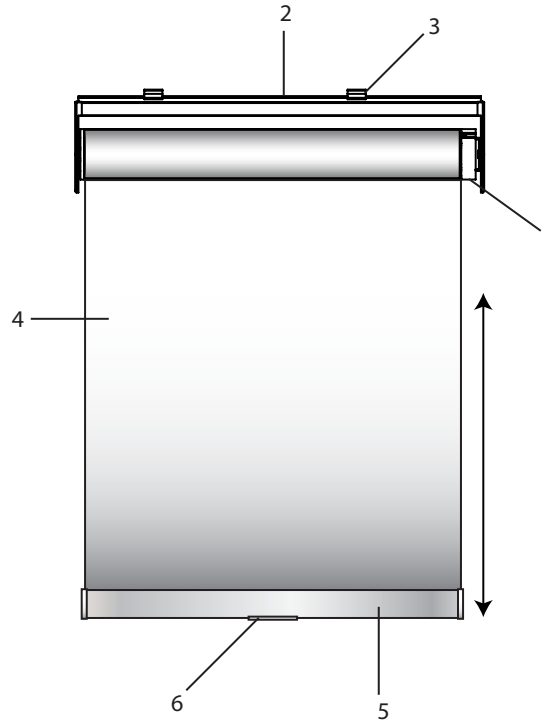

1. Controller
2. Headrail
3. Mounting Bracket
4. Fabric
5. Bottom Bar
6. Bottom Bar Handle

### Parts Included:



Installation Screws



Ceiling Mount Brackets

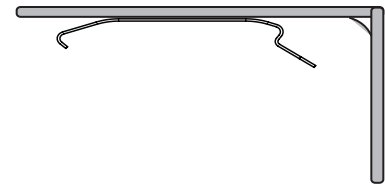

Wall Mount Brackets (optional)

### Tools Needed:



Pencil

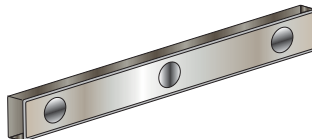

Level

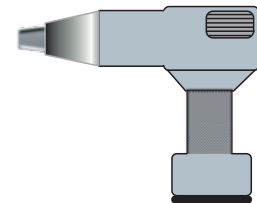

Cordless Drill

### Bracket Installation:

#### INSIDE MOUNT:

For inside ceiling mount, use the provided inside mount brackets.

Using a pencil, mark the positioning of the bracket at least 2" from each end.

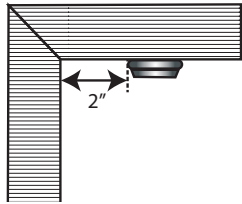

Use the hole in the middle of the bracket to secure it using the provided screws (#2 Robertson).

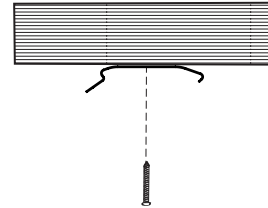

#### OUTSIDE MOUNT:

Outside mount brackets are designed to be secured to the wall. Wall mount brackets are optional and must be specified at the time of purchase. Use a level to ensure the brackets are level with each other. Installing brackets otherwise will cause the fabric to veer and subsequently get damaged.

Using a pencil, mark the positioning of the bracket at least 2" from each end.

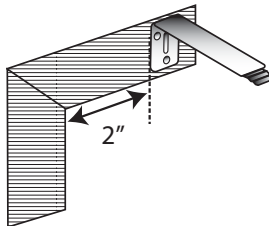

Use the hole in the middle of the bracket to secure it using the provided screws (#2 Robertson).

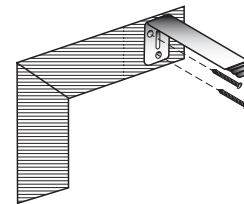

### Headrail Installation:

Hook the front of the headrail to the front of the bracket as shown in the image below.

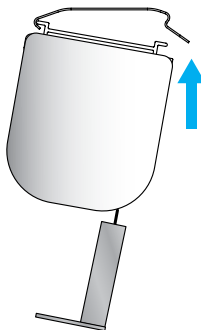

Grab the back side of the headrail and press upwards until you hear a click. Tuck the headrail slightly to ensure its fully locked in.

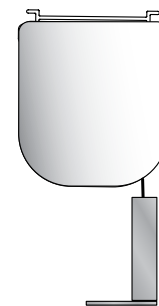

### Headrail Removal:

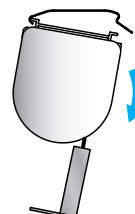
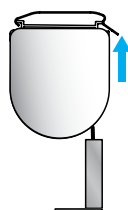

**Shade Operation:**

Using the handle attached to the bottom rail, move the bottom rail up or down to desired position.

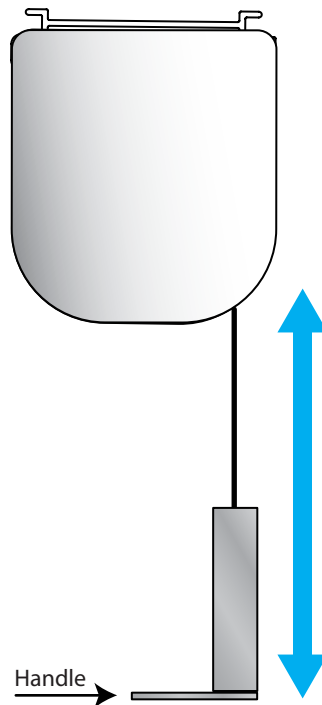
**Troubleshooting:**

PROBLEM	CAUSE	SOLUTION
1. Shade does not reach its bottom limit	Too much tension on the spring	<ol style="list-style-type: none"> <li>1. Raise the shade all the way up</li> <li>2. Remove the shade from the brackets</li> <li>3. Remove the cover on the right (controller side)</li> <li>4. Turn the adjustment screw clockwise to reduce tension. Please make adjustment in 1/4 turns</li> <li>5. Install shade</li> <li>6. Lower shade to its desired lower limit. Note that reducing too much tension on the spring can lower the upper limit of the shade as well.</li> <li>7. If needed, repeat the above process</li> </ol>
2. Shade does not rise to its upper limit	Limiters tension is too low	<ol style="list-style-type: none"> <li>1. Raise the shade all the way up</li> <li>2. Remove the shade from the brackets</li> <li>3. Remove the cover on the left (limiter side)</li> <li>4. Turn the adjustment screw counter-clockwise. Please make adjustment in 1/4 turns</li> <li>5. Install shade</li> <li>6. Lower the shade all the way to its lower limit</li> <li>7. Raise the shade all the way up to desired limit.</li> <li>8. If needed, repeat the above process</li> </ol>